

A-SPOT™ Series

A-Spot™ is an exceptionally high performance LED lamp built to last. It is a premium quality solid state lighting product precisely engineered and manufactured with state of the art technologies and materials.

Proprietary driving circuit enables A-Spot™ to replace traditional incandescent / halogen lamp, up to 50 watt, directly without additional modification or transformer.

Features

- Can replace the conventional spot lights, soft light
- The power is 5W, equivalent to a 40-50W conventional spotlight
- Low heat, No UV, No IR.
- Life Span: 50,000 hours
- Material: Aluminium(shell)+PC(Top)
- Working Voltage: AC100-240V, 50/60Hz; AC/DC12V
- Base: GU10/E26/E27/GU5.3
- Certification: CE, RoHS
- Standard Warranty: 3 Years

Applications

Widely used in the hotel, meeting room, offices, hospital, schools, factories, commercial lighting, shopping malls, supermarkets, kitchen, display, backlight, home indoor lighting and so on.



Dimensions (Unit: mm/inch)

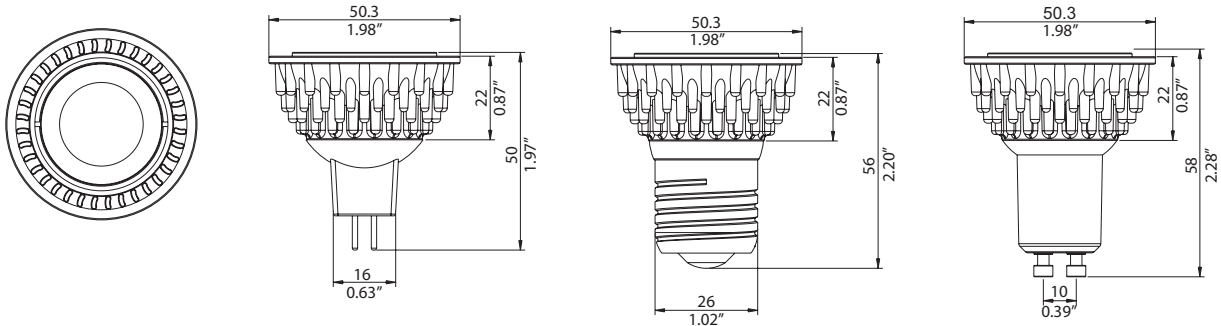

Specifications

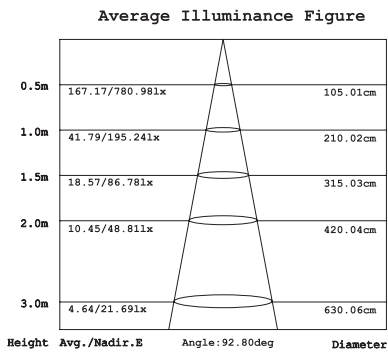

White

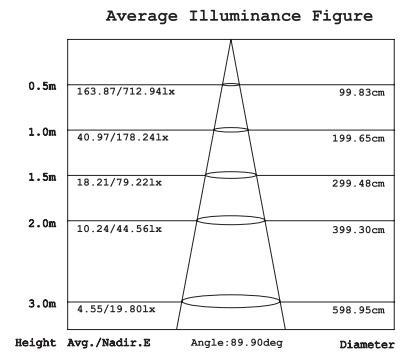
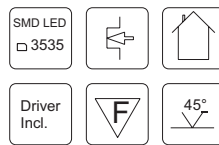

Warm White

Model #	Shell Color	Color	LED Type	CCT	Rated Power Consumption	CRI	Lumen	Voltage Frequency	Beam Angle	Weight
AR-006-AW-01WE27	Black	White	3535 SMD LED	5900K	5W	72	400	100-240Vac 50/60Hz	45°	1.89 ounces (45g)
E27-006-AW-W-01	Silver	White	3535 SMD LED	5900K	5W	72	400	100-240Vac 50/60Hz	45°	
AR-006-AW-01WWE27	Black	Warm White	3535 SMD LED	3100K	5W	76	320	100-240Vac 50/60Hz	45°	
E27-006-AW-WW-01	Silver	Warm White	3535 SMD LED	3100K	5W	76	320	100-240Vac 50/60Hz	45°	
AR-006-AW-01WGU10	Black	White	3535 SMD LED	5900K	5W	72	400	100-240Vac 50/60Hz	45°	
GU10-006-AW-W-01	Silver	White	3535 SMD LED	5900K	5W	72	400	100-240Vac 50/60Hz	45°	
AR-006-AW-01WVGU10	Black	Warm White	3535 SMD LED	3100K	5W	76	320	100-240Vac 50/60Hz	45°	
GU10-006-AW-WW-01	Silver	Warm White	3535 SMD LED	3100K	5W	76	320	100-240Vac 50/60Hz	45°	
AR-006-D5-01WMR16	Black	White	3535 SMD LED	5900K	4.5W	72	400	12Vac/dc	45°	
MR16-006-D5-W-01	Silver	White	3535 SMD LED	5900K	4.5W	72	400	12Vac/dc	45°	
AR-006-D5-01WWMR16	Black	Warm White	3535 SMD LED	3100K	4.5W	76	320	12Vac/dc	45°	
MR16-006-D5-WW-01	Silver	Warm White	3535 SMD LED	3100K	4.5W	76	320	12Vac/dc	45°	

The data of the light output is only from our test reports. It may differentiate another result or source if lamps are tested through other equipments or test methods.

Absolute Maximum Rating

Parameter	Rating	Units
Aluminum Heat sink Temperature	66	° C
Operating Temperature	-20~+40	° C
Storage Temperature	-20~+80	° C
Equilibrium Temperature	60	° C

White (GU10 / E27)

Spectrophotometer Test Report

Light Source Test Report

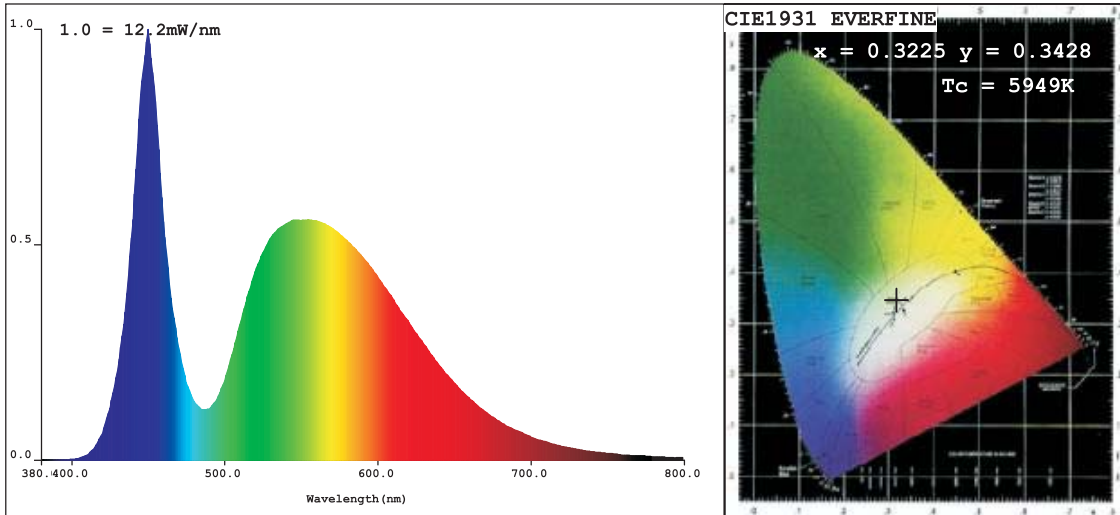

CIE Color Parameters:

Chromaticity Coordinate: $x=0.3225$ $y=0.3428$ / $u'=0.1994$ $v'=0.4769$ ($duv=5.43$)

CCT: $T_c=5949K$ Prcp WaveL: $\lambda_d=503.4nm$ Purity=3.3%

Peak WaveL: $\lambda_p=450nm$ Half Width: $\Delta\lambda_p=22.8nm$ Ratio: R=12.5% G=83.8% B=3.7%

Average Wave: 547nm

Rendering Index: $R_a=71.5$

Photo Parameters:

Flux: $\Phi=399.59(lm)$ Luminous Efficacy: 75.77(lm/W) Luminous Power: $P=1.219(W)$

Electrical Parameters:

$U=205.8V$ $I=0.0526A$ $P=5.273W$ $PF=0.487$

Instrument Status:

Scan Range: 380.0nm-800.0nm

Interval: 5.0nm

$I_p = 31582(G=4, D=48)$

REF = 10068

TMP (PMT) = 25.4(deg.celsius)

Test Mode: Fast Test

GONIOPHOTOMETER Test Report

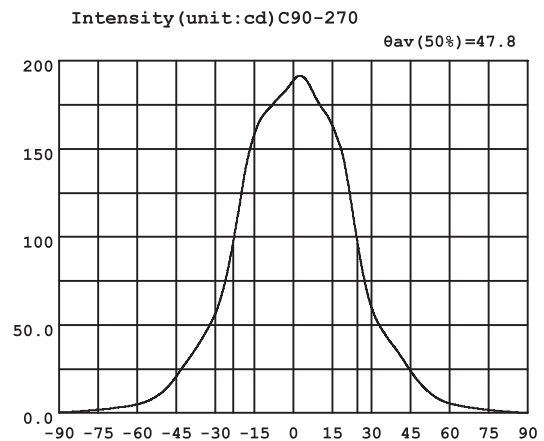
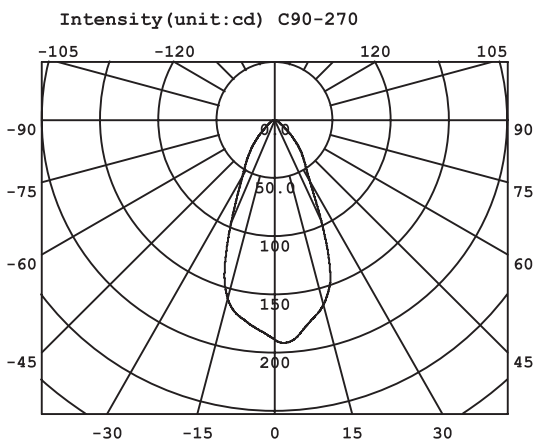

Warm White (GU10/E27)

Spectrophotometer Test Report

Light Source Test Report

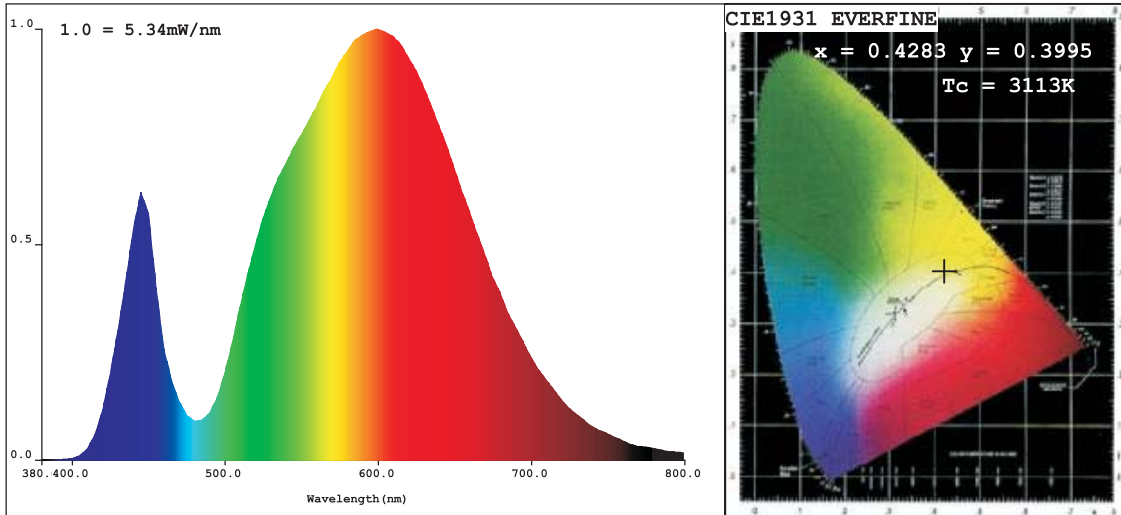

CIE Color Parameters:

Chromaticity Coordinate: $x=0.4283$ $y=0.3995$ / $u'=0.2470$ $v'=0.5183$ ($duv=-5.7$)

CCT: $T_c=3113K$ Prcp WaveL: $\lambda_d=582.6nm$ Purity=48.5%

Peak WaveL: $\lambda_p=600nm$ Half Width: $\Delta\lambda_p=147.6nm$ Ratio: R=21.5% G=76.9% B=1.6%

Average Wave: 590nm

Rendering Index: $R_a=76.9$

Photo Parameters:

Flux: $\Phi=320.16(lm)$ Luminous Efficacy: 59.70(lm/W) Luminous Power: $P=899.6(mW)$

Electrical Parameters:

U=205.8V I=0.0531A P=5.360W PF=0.491

Instrument Status:

Scan Range: 380.0nm-800.0nm

Interval: 5.0nm

$I_p = 23206(G=5, D=49)$

REF = 7226

TMP (PMT) = 24.9(deg.celsius)

Test Mode: Fast Test

GONIOPHOTOMETER Test Report

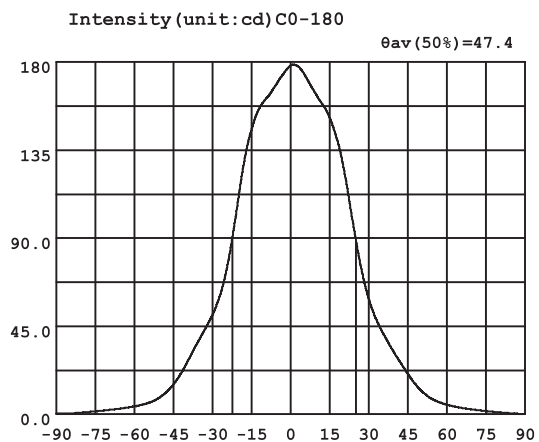
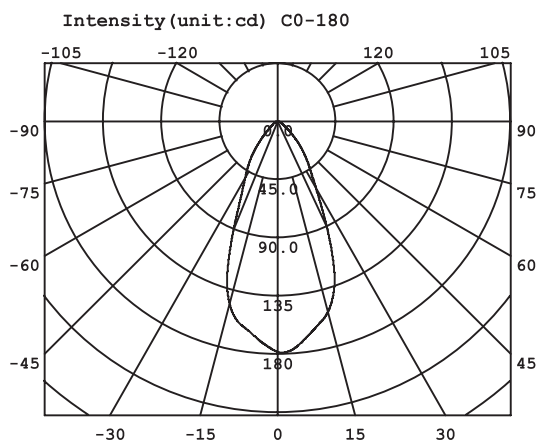

White (MR16)

Spectrophotometer Test Report
Light Source Test Report

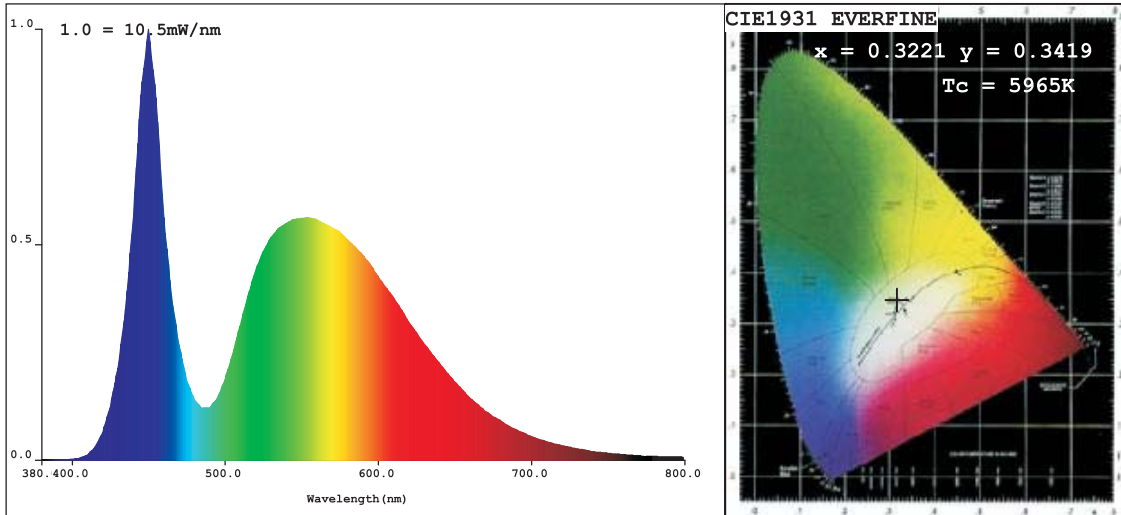

CIE Color Parameters:

Chromaticity Coordinate: $x=0.3221$ $y=0.3419$ / $u'=0.1995$ $v'=0.4764$ ($duv=5.17$)
 CCT: $T_c=5965K$ Prcp WaveL: $\lambda_d=501.9nm$ Purity=3.4%
 Peak WaveL: $\lambda_p=450nm$ Half Width: $\Delta\lambda_p=23.2nm$ Ratio: R=12.5% G=83.8% B=3.7%
 Average Wave: 547nm
 Rendering Index: Ra=71.6

Photo Parameters:

Flux: $\Phi=399.68(lm)$ Luminous Efficacy: 88.97(lm/W) Luminous Power: P=1.059(W)

Electrical Parameters:

U=11.92V I=0.4996A P=4.192W PF=0.704

Instrument Status:

Scan Range: 380.0nm-800.0nm Interval: 5.0nm $I_p = 26837(G=4, D=48)$
 REF = 8734 TMP(PMT) = 24.7(deg.celsius) Test Mode: Fast Test

GONIOPHOTOMETER Test Report

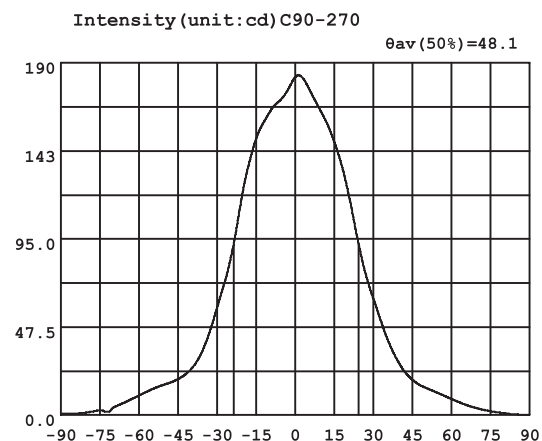
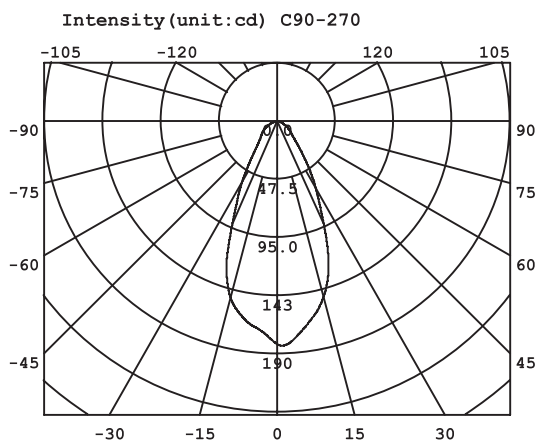

Warm White (MR16)

Spectrophotometer Test Report

Light Source Test Report

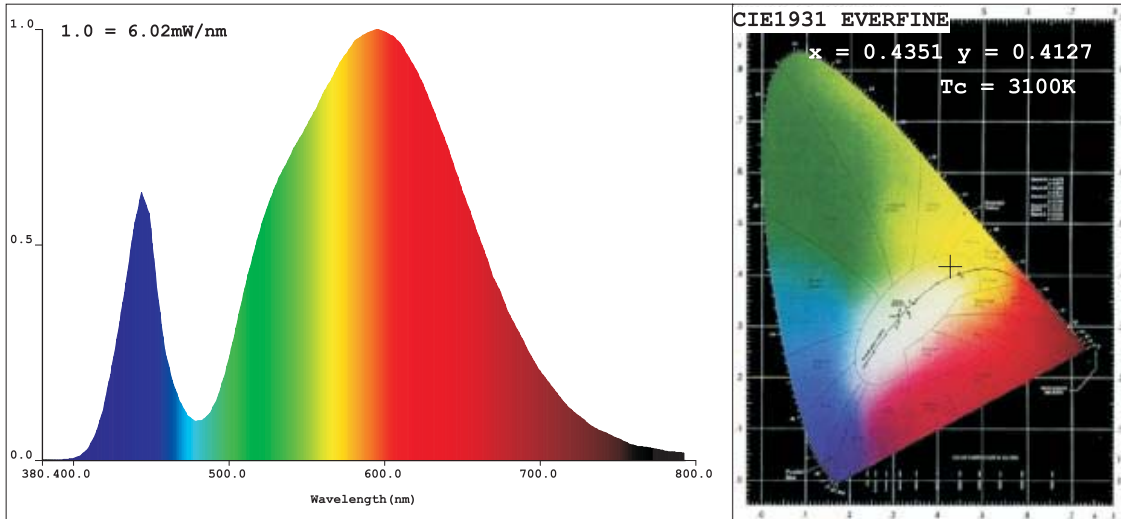

CIE Color Parameters:

Chromaticity Coordinate: $x=0.4351$ $y=0.4127$ / $u'=0.2458$ $v'=0.5244$ (duv=3.66e

CCT: $T_c=3100K$ Prcp WaveL: $\lambda_d=581.2nm$ Purity=54.5%

Peak WaveL: $\lambda_p=600nm$ Half Width: $\Delta\lambda_p=147.1nm$ Ratio: R=21.2% G=77.4% B=1.5%

Average Wave: 591nm

Rendering Index: Ra=75.8

Photo Parameters:

Flux: $\Phi=320.17(lm)$ Luminous Efficacy: 70.58(lm/W) Luminous Power: P=994.1(mW)

Electrical Parameters:

U=11.99V I=0.3781A P=4.536W PF=1.000

Instrument Status:

Scan Range: 380.0nm-800.0nm Interval: 5.0nm $I_p = 22384 (G=5, D=48)$

REF = 7602 TMP(PMT) = 20.4(deg.celsius) Test Mode: Fast Test

GONIOPHOTOMETER Test Report

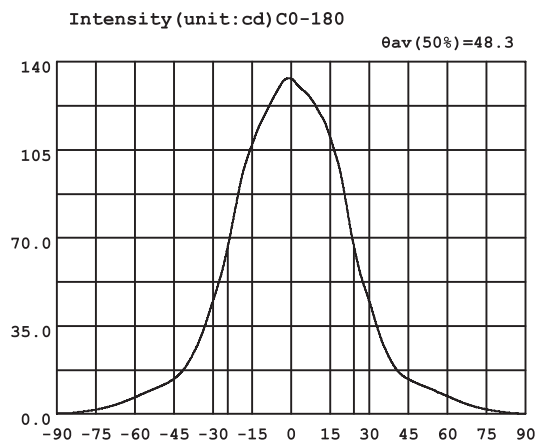
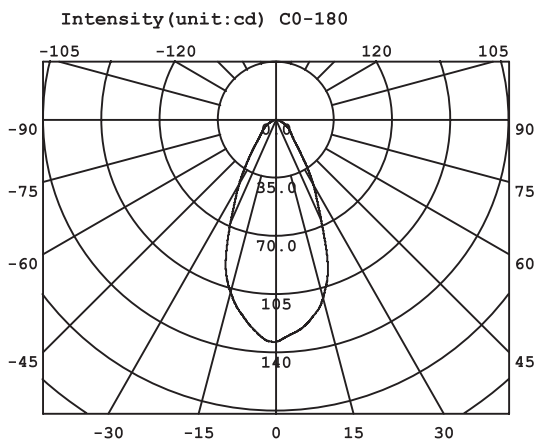

Installation drawing

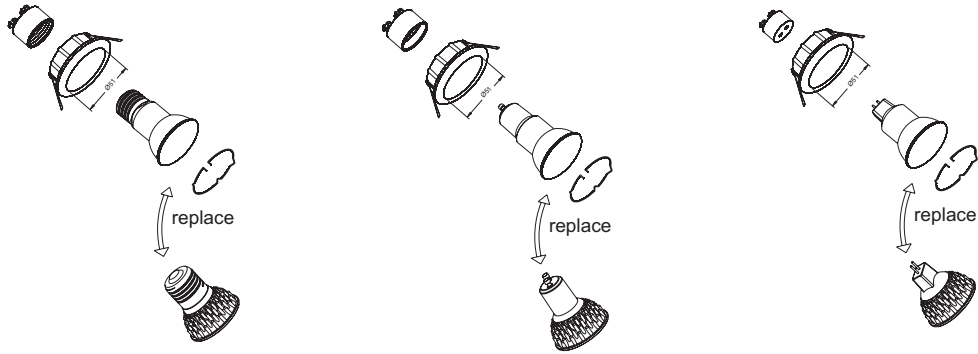

- ⚠ The product is strictly prohibited to be used in these conditions:
- For fixtures and circuits with dimming functions:(neither with 100% full brightness)
 - For fixtures with internal control circuits (not including those which are officially allowed)
 - For conventional direction lamp or exit lights
 - For mercury vapor lamps, sodium lamps or HID lamps
 - For airtight or mechanically sealed fixtures

⚠ CAUTIONS

- Don't install it around a humid environment or place which has water drops.
- Don't drop, scratch or squeeze the bulb.
- Don't take apart the product or replace mechanical and electronic components.
- Care needs to be taken that the light fixture with the bulb is a safe distance from paper, fabric or other inflammables.
- Tighten the bulb base into socket in case to prevent falling out.
- Don't touch the bulb body with fingers after it works for some time as the body temperature is quite warm.
- Do not stare at the strong light for a long time as it may cause injury to eyes.